

..... Model Estimate

**CONSTRUCTION
OF
OFFICE BUILDING
FOR**

GAON PANCHAYAT

UNDER

TASFC 2010-11

ESTIMATED AMOUNT: ₹ 11.00 LAKHS

Name of the Work : Model Estimate for Construction of Office Building of

Goan Panchayat

Head : TASFC 2010-11

Estimated Amount : ₹ 11,00,000.00 (Rupees Eleven Lakhs) only

R E P O R T

Panchayats at different levels play an important role in the implementation of Panchayat & Rural Development Schemes. Panchayats are the principal Implementing Agencies. However most of the Panchayats do not have proper place to efficiently discharge their duties and responsibilities. Strengthening the infrastructure at Goan Panchayat level to effectively and efficiently implement Panchayat & Rural Development Schemes has constantly been demanded.

To strengthen the infrastructure at the Gaon Panchayat level, the State Government has recommended ₹ 11.00 Lakhs under TASFC 2010-11. Accordingly a Model Estimate for Construction of Office Building at Gaon Panchayat Level has been prepared to serve the following purposes :

- i) Providing ample space for the functioning of dedicated personnel
- ii) Enabling Meetings, Assemblies, Gaon Sabhas
- iii) Supporting ICT infrastructure for MIS
- iv) Maintaining office records,
- v) Grievance redressal.
- vi) Enabling social audits
- vii) Training and Capacity Building
- viii) Operationalising ICT based MIS.
- ix) Providing a single window for information on rural development programmes which would ensure transparency and accountability.

These office Buildings will become the hub for :

- i. Facilitating convergence of all the schemes of rural development, as well as of convergence between P & RD schemes and other development programmes related to rural areas/communities.
- ii. Backward and forward linkages, which will be required for convergence for creating more productive and durable assets.
- iii. Collection and sharing of knowledge, awareness and information about other related Schemes for the purpose of convergence.
- iv. Dissemination and use of new technology
- v. Capacity building and skill development

The major functional elements considered for OFFICE AT GAON PANCHAYAT LEVEL are as follows:

- a. Meeting / Training hall
- b. Office space for Rural Development Programmes
- c. Citizen centric interface room
- d. External toilet complex

I am sure, the Office Building would meet the expectations of the all concerned and would accelerate the effective implementation of the P & RD Programmes in compliance with the statutory processes. The Building will provide a common platform for the citizens to exercise their rights and entitlements & to interact and exchange their experiences and provide logistic support and a record keeping facility centre. This Office will function as a Citizen-Centric Knowledge Resource Centre to allow access to information on Panchayat & Rural Development Programmes.

Avinash Joshi, IAS

Commissioner

Panchayat & Rural Development, Govt. of Assam

Juripar : Guwahati : Assam

CONSTRUCTION OF OFFICE BUILDING OF GAON PANCHAYAT
UNDER TASFC 2010-11
ESTIMATED AMOUNT : ₹11.00 LAKHS (RUPEES ELEVEN LAKHS ONLY)

ABSTRACT OF COST

Sl No.	Particulars	Amount	Remarks
1	COST OF PANCHAYAT OFFICE BUILDING	₹ 8,63,500.00	
2	COST OF TOILET BLOCK	₹ 1,52,000.00	
3	COST OF FURNITURE	₹ 16,500.00	
4	COST OF BARBED WIRE FENCING @ `529.68 / RM. => TOTAL LENGTH = 108 RM.	₹ 57,200.00	
5	CONTINGENCY 1%	₹ 11,000.00	
TOTAL AMOUNT (1+2+3+4+5) =		₹ 11,00,200.00	
			Say, ₹ 11,00,000.00 (RUPEES ELEVEN LAKHS ONLY)

A. Rahman

Jt. Director
Panchayat & Rural Development : Assam
Juripar : Guwahati : Assam

Dhrubajyoti Sarmah

Jr. Engineer
Pachim Kaliabor Development Block
Missa : Nagaon : Assam

Construction of Assam Type Office Building for "Gaon Panchayat"

Detailed Estimate for the Office Building

(Schedule of Rates for PWD Building (Civil works) 2010-11)

1	1.1	<p>Earth work in excavation for foundation trances of wall, retaining wall, column etc. including refilling the quantity as necessary after completion of the work, breaking clods in return filling, dressing, watering and remming etc. and removal of surplus earth with all lead and lifts as directed and specified.</p> <p>(A) Up to a depth of 2.00m below the existing ground level</p> <p>a) In ordinary soil</p> <table border="0" style="width: 100%; border-collapse: collapse;"> <tr> <td style="width: 10%;">Post</td> <td style="width: 10%;">18 X</td> <td style="width: 10%;">1.00X</td> <td style="width: 10%;">1.00X</td> <td style="width: 10%;">1.20=</td> <td style="width: 10%;">31.10 m3</td> <td></td> <td></td> </tr> <tr> <td></td> <td>8 X</td> <td>2.75X</td> <td>0.40X</td> <td>0.45=</td> <td>3.96 m3</td> <td></td> <td></td> </tr> <tr> <td></td> <td>2 X</td> <td>2.35X</td> <td>0.40X</td> <td>0.45=</td> <td>0.85 m3</td> <td></td> <td></td> </tr> <tr> <td></td> <td>2 X</td> <td>1.00X</td> <td>0.40X</td> <td>0.45=</td> <td>0.36 m3</td> <td></td> <td></td> </tr> <tr> <td></td> <td>1 X</td> <td>3.00X</td> <td>0.40X</td> <td>0.45=</td> <td>0.54 m3</td> <td></td> <td></td> </tr> <tr> <td></td> <td>4 X</td> <td>2.60X</td> <td>0.40X</td> <td>0.45=</td> <td>1.87 m3</td> <td></td> <td></td> </tr> <tr> <td></td> <td>5 X</td> <td>1.40X</td> <td>0.40X</td> <td>0.45=</td> <td>1.26 m3</td> <td></td> <td></td> </tr> <tr> <td></td> <td>2 X</td> <td>0.90X</td> <td>0.40X</td> <td>0.45=</td> <td>0.32 m3</td> <td></td> <td></td> </tr> <tr> <td></td> <td>Step</td> <td>2 X</td> <td>2.00X</td> <td>1.00X</td> <td>0.20=</td> <td>0.80 m3</td> <td></td> <td></td> </tr> <tr> <td></td> <td></td> <td></td> <td></td> <td></td> <td style="border-top: 1px solid black;">41.06 m3</td> <td></td> <td></td> </tr> </table>	Post	18 X	1.00X	1.00X	1.20=	31.10 m3				8 X	2.75X	0.40X	0.45=	3.96 m3				2 X	2.35X	0.40X	0.45=	0.85 m3				2 X	1.00X	0.40X	0.45=	0.36 m3				1 X	3.00X	0.40X	0.45=	0.54 m3				4 X	2.60X	0.40X	0.45=	1.87 m3				5 X	1.40X	0.40X	0.45=	1.26 m3				2 X	0.90X	0.40X	0.45=	0.32 m3				Step	2 X	2.00X	1.00X	0.20=	0.80 m3								41.06 m3			Rs.64.67	Rs.2,655.35	
Post	18 X	1.00X	1.00X	1.20=	31.10 m3																																																																																	
	8 X	2.75X	0.40X	0.45=	3.96 m3																																																																																	
	2 X	2.35X	0.40X	0.45=	0.85 m3																																																																																	
	2 X	1.00X	0.40X	0.45=	0.36 m3																																																																																	
	1 X	3.00X	0.40X	0.45=	0.54 m3																																																																																	
	4 X	2.60X	0.40X	0.45=	1.87 m3																																																																																	
	5 X	1.40X	0.40X	0.45=	1.26 m3																																																																																	
	2 X	0.90X	0.40X	0.45=	0.32 m3																																																																																	
	Step	2 X	2.00X	1.00X	0.20=	0.80 m3																																																																																
					41.06 m3																																																																																	
2	1.4	<p>Raising low site or toe side around the building with approved soil obtained from out side by truckcarriage including breaking clods, dressing etc. complete includingh paying land compensation, Municipal gate fees, if any monopoly duty etc. (Profile measurement tobe taken and 12.5 % deduction for shrinkage to be made from total quantity) etc. complete as directed and specified including forest royalty within a distance of 8.00km (Forest royalty shall be reimbursed on production of necessary certificate from the forest Authority duly countersigned from DFO concerned</p>																																																																																				
		Other than Guwahati	1 X	30.00 X	18.00	0.30=	162.00 m3	Rs.205.52	Rs.33,294.24																																																																													
3	4.1.1	<p>Providing soling in foundation and under floor at all level in cluding all cost of labour and materials complete</p> <p>a) Brick flat soling</p> <table border="0" style="width: 100%; border-collapse: collapse;"> <tr> <td style="width: 10%;">Post</td> <td style="width: 10%;">18X</td> <td style="width: 10%;">1X</td> <td style="width: 10%;">1.20X</td> <td style="width: 10%;">1.20=</td> <td style="width: 10%;">25.92m2</td> <td></td> <td></td> </tr> <tr> <td></td> <td>8X</td> <td>1X</td> <td>3.50X</td> <td>0.40=</td> <td>11.20m2</td> <td></td> <td></td> </tr> <tr> <td></td> <td>2X</td> <td>1X</td> <td>3.10X</td> <td>0.40=</td> <td>2.48m2</td> <td></td> <td></td> </tr> <tr> <td></td> <td>2X</td> <td>1X</td> <td>1.75X</td> <td>0.40=</td> <td>1.40m2</td> <td></td> <td></td> </tr> <tr> <td></td> <td>1X</td> <td>1X</td> <td>3.75X</td> <td>0.40=</td> <td>1.50m2</td> <td></td> <td></td> </tr> <tr> <td></td> <td>4X</td> <td>1X</td> <td>3.35X</td> <td>0.40=</td> <td>5.36m2</td> <td></td> <td></td> </tr> <tr> <td></td> <td>5X</td> <td>1X</td> <td>2.15X</td> <td>0.40=</td> <td>4.30m2</td> <td></td> <td></td> </tr> <tr> <td></td> <td>2X</td> <td>1X</td> <td>1.65X</td> <td>0.40=</td> <td>1.32m2</td> <td></td> <td></td> </tr> <tr> <td></td> <td>Step</td> <td>2X</td> <td>1X</td> <td>2.00X</td> <td>1.00=</td> <td>4.00m2</td> <td></td> <td></td> </tr> <tr> <td></td> <td></td> <td></td> <td></td> <td></td> <td style="border-top: 1px solid black;">57.45m2</td> <td></td> <td></td> </tr> </table>	Post	18X	1X	1.20X	1.20=	25.92m2				8X	1X	3.50X	0.40=	11.20m2				2X	1X	3.10X	0.40=	2.48m2				2X	1X	1.75X	0.40=	1.40m2				1X	1X	3.75X	0.40=	1.50m2				4X	1X	3.35X	0.40=	5.36m2				5X	1X	2.15X	0.40=	4.30m2				2X	1X	1.65X	0.40=	1.32m2				Step	2X	1X	2.00X	1.00=	4.00m2								57.45m2					
Post	18X	1X	1.20X	1.20=	25.92m2																																																																																	
	8X	1X	3.50X	0.40=	11.20m2																																																																																	
	2X	1X	3.10X	0.40=	2.48m2																																																																																	
	2X	1X	1.75X	0.40=	1.40m2																																																																																	
	1X	1X	3.75X	0.40=	1.50m2																																																																																	
	4X	1X	3.35X	0.40=	5.36m2																																																																																	
	5X	1X	2.15X	0.40=	4.30m2																																																																																	
	2X	1X	1.65X	0.40=	1.32m2																																																																																	
	Step	2X	1X	2.00X	1.00=	4.00m2																																																																																
					57.45m2																																																																																	
		Under floor	1X	14.20X	3.40=	48.28m2																																																																																
			1X	14.20X	2.20=	31.24m2																																																																																
			1X	7.90X	1.90=	15.01m2																																																																																
					B=	94.53m2																																																																																
					A+B=	152.01 m2	Rs.286.37	Rs.43,531.10																																																																														
4	2.1.1	Providing and laying PCC work in foundation																																																																																				

	b) In prop. 1:4:8											
		1X	1X	57.48X	0.075=	4.31	m3					
5	18.1.1	Supplying fitting and fixing reinforcement bars conforming to IS for RCC work including straightening, cutting and bending to proper shape and length upto 1st floor level.									Rs.3,398.10	Rs.14,645.81
	b) ISI approved super ductile TMT bars											
	i) TATA/SAIL	12mm dia										
	Post	18X	4X	6.00X	0.89=	384.48	kg					
		2X	4X	15.50X	0.89=	110.36	kg					
		2X	4X	0.60X	0.89=	4.27	kg					
		2X	4X	3.85X	0.89=	27.41	kg					
		1X	4X	8.80X	0.89=	31.33	kg					
		2X	4X	6.50X	0.89=	46.28	kg					
		2X	4X	4.10X	0.89=	29.19	kg					
		2X	4X	2.90X	0.89=	20.65	kg					
		2X	4X	2.40X	0.89=	17.09	kg					
	10mm dia											
	Lintel	2X	4X	15.30X	0.62=	75.89	kg					
	Lapping	2X	4X	0.45X	0.62=	2.23	kg					
		2X	4X	3.65X	0.62=	18.10	kg					
		1X	4X	8.60X	0.62=	21.33	kg					
		2X	4X	6.30X	0.62=	31.25	kg					
		2X	4X	3.90X	0.62=	19.34	kg					
		2X	4X	2.70X	0.62=	13.39	kg					
		2X	4X	2.20X	0.62=	10.91	kg					
						192.45	kg					
	Post Plate											
	8mm dia	18X	14X	0.75X	0.39=	73.71	kg					
						1129.67	kg					
						11.3	Qtl					
	c) ISI approved M S Rod (6 mm dia)											
	Post	18X	43X	0.60X	0.22=	102.17	kg					
	Gabble Post	3X	10X	0.60X	0.22=	3.96	kg					
	Lintel	1X	473X	0.60X	0.22=	62.44	kg					
		1X	473X	0.60X	0.22=	62.44	kg					
	Tie Beam	1X	459X	0.60X	0.22=	92.9	kg					
	Protruding	18X	12X	0.60X	0.22=	28.51	kg					
						352.41	kg					
						3.52	Qtl					
								Rs.5,290.41		Rs.59,781.63		
6	3.1.1	Providing from work of ordinary timber planking so as to give a rough finish.										
		In sub structure upto plinth										
	3.1.1.1	Foundation footing, bases of Column, tie and the like up to plinth level										
		ii) Using 25mm thick plank.										
	Post	18X	4X	0.80X	0.15=	8.64	m2					
		18X	4X	0.52X	0.15=	5.62	m2					
		18X	4X	0.25X	1.90=	34.20	m2					
						48.46	m2					
								Rs.140.84		Rs.6,825.11		
	3.1.1.2	Sides of tiebeam, plinth beam, grade beam etc. at or below plinth level										
		ii) Using 25mm thick plank										
	Tie Beam	1X	2X	68.90X	0.25=	34.45	m2					
								Rs.191.27		Rs.6,589.25		
	3.1.1.3	Column pillars, post and struts.										
		a) Square, rectangular, polygonal in plan or any shape like Tee/L etc.having plan vertical face										
		ii) Using 25mm thick plank										
		18X	4X	0.15X	3.30=	35.64	m2					
		3X	4X	0.15X	1.20=	2.16	m2					
						37.80	m2					
								Rs.213.73		Rs.8,078.99		

3.1.1.4	Sides and soffits of beam, beam haunching cantilever girder, bressumers, lintels and horizontal ties						
	a) for depth not exceeding 1.0m						
	ii) Using 25mm thick plank						
	Lintel	1X	2X	71.30X	0.15=	21.39	m2
		1X	1X	71.30X	0.13=	9.27	m2
	Post Plate	1X	2X	71.30X	0.15=	21.39	m2
						52.05	m2
						Rs.163.01	Rs.8,484.67
7	2.2.1	Providing and laying plain/reinforced cement concrete works in prop 1:2:4:(1cement:2 coarse sand :4 graded stone aggregate, 20mm down) including dewatering if necessary, and curing complete but excluding cost of form work and reinforcement for reinforced cement concrete work.					
	a) In substructure upto plinth level						
	Foundation, footing, columns with basetie and plinth beam, pile cap, base slab, retaining wall, walls of septic tank, inspectionpit and the like, and other works not less than 100mm thickup to plinth level						
	Column.	18X	0.8X	0.8X	0.15=	1.73	m3
		18X	0.52X	0.52X	0.15=	0.73	m3
		18X	0.23X	0.23X	1.90=	1.81	m3
		1X	68.90X	0.25X	0.25=	4.31	m3
						8.57	m3
						Rs.4,734.15	Rs.40,571.67
	b) In super structure from plinth level up to 1st floor level.						
	ii) Columns, pillars, posts, struts, suspended floor, roof, landing, shelf and support, balcony, lintel, sill band, beam, girder, bressumer4, cantilever, staircase including preparing the top surface and finishing of nosing.						
	Post	18X	3.60X	0.15X	0.15=	1.46	m3
		3X	1.20X	0.15X	0.15=	0.08	m3
	Lintel	1X	71.30X	0.13X	0.15=	1.39	m3
	Post Plate	1X	71.30X	0.13X	0.15=	1.39	m3
						4.32	m3
						Rs.4,929.24	Rs.21,294.32
8	4.1.4	Brick work in cement mortar with 1st class brick including racking out joint and dewatering if necessary, curing complete as directed in sub-structure upto plinth level.					
	d) In prop 1:6						
		1X	41.75X	0.23X	0.60=	5.76	m3
		1X	27.15X	0.125X	0.60=	2.04	m3
	Step	2X	2.00X	0.90X	0.20=	0.72	m3
		2X	2.00X	0.60X	0.15=	0.36	m3
		2X	1.20X	0.30X	0.15=	0.11	m3
						8.99	m3
						Rs.4,401.57	Rs.39,570.11
9	2.1.3	Providing and laying 25mm thick damp proof coarse with cement concrete in prop 1:1.5:3 with graded stone aggregate of 10mm down nominal size including providing approved damp proof admixture in propportion as recommended by the manufacturer including etc. complete as directed.					
		1X	1X	38.90X	0.13=	5.06	m2
						Rs.150.00	Rs.759.00
10	1.3	Earth/Sand filling in plinth in layers not more than 15cm thick, including necessary carriage, watering, ramming, etc. complete as directed and specified including payment of land compensansation, forest royelty, sales tax and other duties and taxes may be necessary.					
	C) With riversand or silt by truck carriage including loading and unli/oading						

11 4.1.7	Under floor	1.00X	94.53X	0.60=	56.72	m3	Rs.322.75	Rs.18,306.38	
	112mm thick 1st class brick nogged wall in cement mortar including racking out joints and curing complete as directed in super structure above plinth upto 1st floor level (Protruding MS rod/torsteel of column to be embedded in cement mortar and will be measured and paid separately)								
	a) in prop 1:5								
	Walls	1X	1X	71.30X	3.00=	213.90	m2		
	Gabble	2X	0.5X	6.00X	1.20=	7.20	m2		
		1X	0.5X	8.30X	1.20=	4.98	m2		
	Less Opening	(-)1X	1X	4.00X	2.20=	(-)8.80	m2		
		(-)2X	1X	1.80X	2.20=	-7.90	m2		
	Less Door	(-)5X	1X	1.00X	2.10=	-10.50	m2		
		(-)1X	1X	0.80X	2.10=	-1.68	m2		
	W	(-)6X	1X	2.00X	1.35=	-16.20	m2		
	W1	(-)4X	1X	1.00X	1.35=	-5.40	m2		
	W2	(-)2X	1X	1.00X	0.60=	-1.80	m2		
	V	(-)6X	1X	2.00X	0.50=	-6.00	m2		
	V1	(-)4X	1X	1.00X	0.50=	-2.00	m2		
	V2	(-)2X	1X	1.00X	0.50=	-1.00	m2		
						164.78	m2		
12 9.1.2	Providing wood works in frame (Chowkath) of doors, windows and other similar works wrought, framed and fixed in position in contact with CC or brick masonry wall including supplying fitting and fixing with MS hold fast (40mm X 3mm X 250mm) as per design embedded in cement concrete block in prop. 1:2:4 and two coats kiricide oiling to the timber faces in contact with CC and masonry as directed and specified.							Rs.499.76	Rs.82,350.45
	b) Hollock/Bonsum/Sundi								
	D-	5X	5.20X	0.075X	0.15=	0.293	m3		
		1X	5.00X	0.075X	0.15=	0.056	m3		
						0.349	m3		
13 11.1.1	Providing fitting and fixing anodised aluminium windows and ventilators of standard sections without horizontal glazing bars, jointsmitred and welded fitted with 6mm X 3.15mm lugs 100mm long embedded in CC blocks handles, friction stays, joining cleat, bolting device, locking arrangement, spring catch as required complete as specified and directed for all levels.(cement concrete to be measured and paid separately).							Rs.46,853.38	Rs.16,351.83
	a) Side hung and top hung windows and ventilators								
	i) 6mm clear glass								
	W	2X	1X	2.00X	1.35=	5.40	m2		
	W1	6X	1X	1.00X	1.35=	8.10	m2		
	W2	4X	1X	1.00X	0.90=	3.60	m2		
	V	2X	1X	2.00X	0.50=	2.00	m2		
	V1	6X	1X	1.00X	0.50=	3.00	m2		
	V2	4X	1X	1.00X	0.50=	2.00	m2		
						24.10	m2		
14 17.3.1	Providing fitting hoisting and fixing of roof trusses including purlins fabricated out of MS black tubes conforming to IS code as per approved design and drawing including providing MS cleats, base plates, bolts and nuts and one coat of red oxide primer as directed.							Rs.4,640.30	Rs.1,11,831.23
8.30M	60.30mm OD - 3.65mm thick @ Wt. 5.10kg/m								
	Tie	2X	1X	8.30=	16.60	m			

	Rafter	2X	2X	5.10=	20.40	m		
6.20M	Tie	5X	1X	6.20=	31.00	m		
	Rafter	5X	2X	4.20=	42.00	m		
					110	m		
				.@Wt.	5.10kg/m		561.00	kg
	Other member 48.30mm - 3.25mm thick @ Wt.3.61kg/m							
8.00m	Vertical	2X	1X	1.60=	3.20	m		
		2X	2X	1.00=	4.88	m		
		2X	2X	0.85=	3.40	m		
	Slant	2X	2X	1.90=	7.60	m		
		2X	2X	1.67=	6.68	m		
		2X	2X	1.30=	5.20	m		
					30.96	m		
				.@Wt.	3.15kg/m		111.77	kg
	42.40mm - 3.25mm thick @ Wt. 3.15kg/m							
6.00M	Vertical	5X	1X	1.60=	8.00	m		
		5X	2X	1.10=	11.00	m		
		5X	2X	0.56=	5.60	m		
	Slant	5X	2X	1.88=	18.80	m		
		5X	2X	1.48=	14.80	m		
	Purlin	8X	1X	16.00=	128.00	m		
		10X	1X	5.60=	56.00	m		
	C. Rafter	2X	2X	6.10=	24.40	m		
					266.60	m		
				.@Wt.	3.61kg/m		839.79	kg
							1512.56	kg
	Nuts & Bolts, Cleats, angles etc.						90.00	kg
							1602.56	kg
	1.52			Total	1.600	Mt.		
15 8.1.2	Providing GCI sheet roofing of TATA Shaktee/SAIL including fitting and fixing of J or L hooks, bolts and nuts with bitumen washer 25mm dia, limpet washer 1.60mm thick excluding cost of roof truss, purlin etc.						Rs.58,750.00	Rs.94,000.00
	b) 0.50 mm thick							
		2X	16.00X	4.20=	134.40			
		2X	1.80X	5.10=	18.36			
					152.76=	153	Rs.359.88	Rs.55,061.64
16 8.1.4	Providing Galvd. Iron ridging of TATA Shaktee/ SAIL including supplying and fixing necessary Galvd. Screws and washer etc. complete as directed.							
	b) 0.50 mm thick							
	i) 150 mm lapping					22.00	Rs.112.23	Rs.2,469.06
17 9.3.1	Providing wood work in frames of false ceiling, partition etc. sawn, wrough framed hoisted and fixed in position with splkes, nails, MS flats, angle/ cleatswith bolts and nuts complete including kiricide oilling two coats tounexposed surface of timber (MS flats, angle, cleats, bolts and nuts etc. shall be measured and paid separately.							
	b) Hollock/Bansum/Sundi							
	Hall	4X	3.60X	0.05X	0.075=	0.054		m3
	16	4X	3.60X	0.05X	0.075=	0.054		m3
		4X	5.80X	0.05X	0.075=	0.087		m3
	24	6X	3.60X	0.05X	0.075=	0.081		m3
		4X	5.00X	0.05X	0.075=	0.075		m3
	24	6X	3.60X	0.05X	0.075=	0.081		m3
		3X	3.35X	0.05X	0.075=	0.038		m3
	24	4X	2.25X	0.05X	0.075=	0.034		m3
		3X	8.15X	0.05X	0.075=	0.092		m3
	24	8X	2.00X	0.05X	0.075=	0.060		m3

	112 Gutka	120X	0.35X	0.05X	0.075=	0.158	m3			
	Struts	26X	1.20X	0.05X	0.075=	0.117	m3			
						0.93	m3	Rs.29,812.40	Rs.27,725.53	
18 7.2.1	Providing fitting and fixing AC building board in ceiling with necessary nails, wood screws including 1st class local wood 50mm x 12mm (Hollock/Bonsum/Sundi) beadings including paintings to timber beads complete as directed (ceiling joist will be measured and paid superately)							0.655		
	a) 4.00mm thick							0.16375		
	Under floor									
		1X	3.60X	3.60=		12.96	m2			
		1X	5.80X	3.60=		20.88	m2			
		1X	4.90X	3.60=		17.64	m2			
		2X	3.35X	2.25=		15.08	m2			
		1X	8.15X	1.90=		15.49	m2			
						82.04	m2	Rs.269.44	Rs.22,104.86	
19 9.4.1	Providing barge board of size 200mm x 20mm with 1st class local Hollock/Bonsum timber including fitting and fixing with necessary wood screws etc. complete.									
	barge board									
		2X	2X	4.20=		16.80	m			
		2X	1X	6.00=		12.00	m			
		1X	1X	16.20=		16.20	m			
		2X	1X	4.00=		8.00	m			
						53.00	m	Rs.224.81	Rs.11,914.93	
20 8.1.8	Providing 13mm mesh hexagonal wire net made of one IS designation (1mm dia) wire above post plate in eaves with 1st class (Hollock / Bonsum) timber frame to fit exactly with the corrugation of roofing sheet including painting two coats with approved paint to timber works complete as directed.									
						12.00	Sqm	Rs.451.43	Rs.5,417.16	
21 5.1.5	65mm thick C.C. floor of 53 mm under layer of CC in prop. 1:3:6 and 12mm thick wearing coarse of cement and plastering in prop. 1:2 laid in panels and finished with a floating coat of neat cement finish.									
						95.00	Sqm	Rs.435.43	Rs.41,365.85	
22 6.2.2	15mm thick cement plaster in single coat on rough side of single or half brick wall for interior plastering upto 1st floor level including arises, internal rounded angles not exceeding 80mm girth, including curing complete as directed.									
	c) In cement mortar 1:6									
		2X	1X	71.30X	3.30=	470.58	Sqm			
	Deduct Exterior surface									
		- 2X	1X	8.00X	3.30=	- 52.80	Sqm			
		- 2X	1X	15.00X	3.30=	- 99.00	Sqm			
	Openings	- 1X	1X	4.00X	2.10=	- 8.40	Sqm			
		- 2X	1X	1.80X	2.10=	- 7.56	Sqm			
	Less Door	- 5X	2X	1.00X	2.10=	- 21.00	Sqm			
		- 1X	2X	1.00X	2.10=	- 4.20	Sqm			
	W	- 2X	1X	2.00X	1.35=	- 5.40	m2			
	W1	- 6X	1X	1.00X	1.35=	- 8.10	m2			
	W2	- 4X	1X	1.00X	0.90=	- 3.60	m2			
	V	- 2X	1X	2.00X	0.50=	- 2.00	m2			
	V1	- 6X	1X	1.00X	0.50=	- 3.00	m2			

	V2	- 4X	1X	1.00X	0.50=	- 2.00	m2		
						253.52	Sqm	Rs.95.10	Rs.24,109.75
23	6.2.3	15mm thick cement plaster in single coat on fair side of single or half brick wall for interior plastering including arises, including curring complete as directed.							
		c) In cement mortar 1:6							
		2X	1X	8.00X	3.30=	52.8	Sqm		
		2X	1X	15.00X	3.30=	99.00	Sqm		
	Openings	- 1X	1X	4.00X	2.10=	- 8.40	Sqm		
		- 2X	1X	1.80X	2.10=	- 7.56	Sqm		
	W	- 2X	1x	2.00X	1.35=	- 5.40	m2		
	W1	- 4X	1x	1.00X	1.35=	- 5.40	m2		
	W2	- 4X	1X	1.00X	0.90=	- 3.60	m2		
	V	- 2X	1X	2.00X	0.50=	- 2.00	m2		
	V1	- 4X	1X	1.00X	0.50=	- 2.00	m2		
	V2	- 4X	1X	1.00X	0.50=	- 2.00	m2		
	Chajja	2X	2x	2.60X	0.60=	6.24	Sqm		
		2X	2x	2.20X	0.60=	5.28	Sqm		
		2X	2x	8.00X	0.60=	19.20	Sqm		
		2X	2x	2.00X	0.60=	4.80	Sqm		
		1X	2x	8.40X	0.60=	10.08	Sqm		
						161.04	Sqm	Rs.94.06	Rs.15,147.42
24	5.1.10	Cement plaster skirting with cement mortar 1:3 finished with a floating coat of neat cement including rounding of junction with floor.							
		a) 15mm thick							
		2X	1X	15.00X	0.65=	19.50	Sqm		
		2X	1X	8.30X	0.65=	10.79	Sqm		
	Steps	2X	3X	2.00X	0.30=	3.60	Sqm		
	Sides	2X	2X	0.90X	0.30=	1.08	Sqm		
						34.97	Sqm	Rs.170.47	Rs.5,961.34
25	9.9.2	Providing fitting and fixing full panelled doors/windows including oxidised MS butt hinges (100mm X 75mm X 3.55mm) with necessary screws. (other fittings to be measured and paid separately)							
		b) With 1st class wood (Hollock/Bonsum)							
		ii) 35mm thick							
	Door	5X	1X	0.93X	2.05=	9.53	m2		
		1X	1X	0.68X	2.05=	1.39	m2		
						10.93	m2	Rs.1,725.92	Rs.18,864.31
26	10.2	Providing fitting and fixing M.S grill of required pattern for window/clerestory window/openings with M.S flats at required spacings in frame all round square or round MS bars with round headed nuts and bolts or screws.							
		l) Plain grill							
		c) Fixed to Brickwork / P.C.C. / R.C.C.							
		2X	2.00X	1.35X	18.00=	97.20			
		6X	1.00X	1.35X	18.00=	145.80			
		4X	1.00X	0.90X	18.00=	64.80			
		2X	2.00X	0.5X	18.00=	36.00			
		6X	1.00X	0.5X	18.00=	54.00			
		4X	1.00X	0.5X	18.00=	36.00			
						433.80	kg	Rs.65.55	Rs.28,435.59

27	13.2.2	(f) Distempering with dry distemper approved brand and manufacture (two Coats) and of required shade on new wall surface to give an even shade over and including priming coat of white primer after thoroughly brushing the surface free from mortar droppings and other foreign matter and including preparing the surface even and sand papered smooth	253.52 m2	Rs.62.42	Rs.15,824.72
28	13.2.3	b) Finishing wall with water proofing cement paint of approved brand on new wall surface (Two coats) to give an even shade after thoroughly brooming the surface to remove all dirt and remains of loose powdered materials.	161.04 m2	Rs.40.83	Rs.6,575.26
29	13.6.3	Applying priming coat over new wood based surface over 100mm in width/girth after and including preparing the surface by thoroughly cleaning oil, grease, dirt and foreign matter, sand papering and knotting. b) With ready mixed paint, wood primer (White)			
		D	5X 2.5X 1.05X 2.10= 27.56 m2		
			1X 2.5X 0.80X 2.10= 4.20 m2		
		barge board	1X 1X 0.25X 53.00= 13.25 m2		
		Ceiling	1X 1X 1.00X 82.04= 82.04 m2		
			127.05 m2	Rs.30.91	Rs.3,927.12
30	13.6.5	Painting two coat s (excluding priming coat) on new wood based surface with enamel paint of approved brand and manufacture to give an even shade including cleaning the surface of dirt, dust and other foreign matter sand papering and stopping. i) Surface over 100mm in idth or girth. b) High gloss	127.05 Sqm	Rs.54.82	Rs.6,964.88
31	15.2.1	Supplying fitting and fixing anodised aluminium fittings of approved make resonably smooth, free from sharp edges including necessary screws a) Sliding door bolt i) 300 mm X 16 mm b) Tower bolt ii) 250 X 12mm c) Door Handle iii) 150 mm	5.00 Each	Rs.290.34	Rs.1,451.70
			10.00 Each	Rs.119.59	Rs.1,195.90
			10.00 Each	Rs.75.37	Rs.753.70
					Rs.9,22,642.93
				Less for Contractor's profit =	Rs.92,264.29
				Internal Electrification (4 % cost of Civil Works) =	Rs.33,215.15
					Cost for the Construction of the Building = Rs.8,63,593.78
					Say, Rs.8,63,500.00
					(Rupees Eight Lakhs Sixty Three Thousand Five Hundred only)

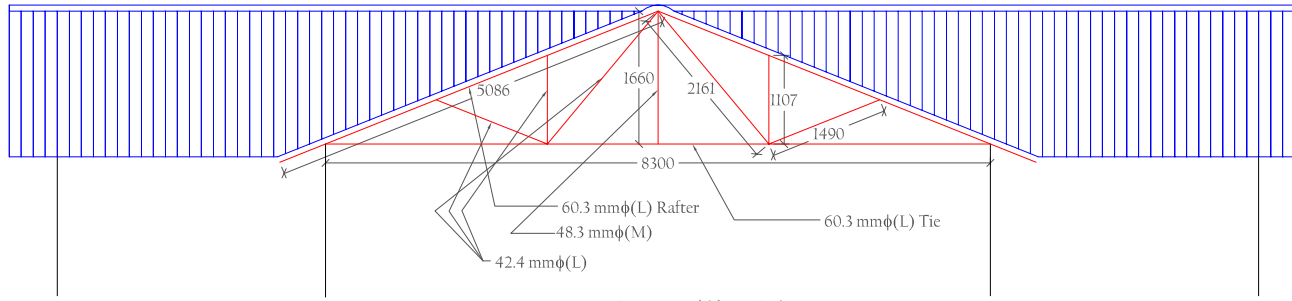

ROOF TRUSS (A) DETAILS

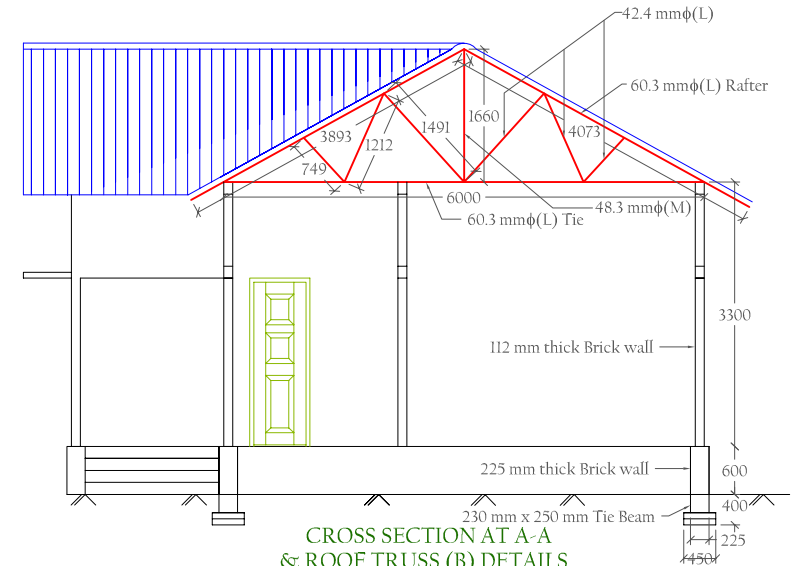

CROSS SECTION AT A-A & ROOF TRUSS (B) DETAILS

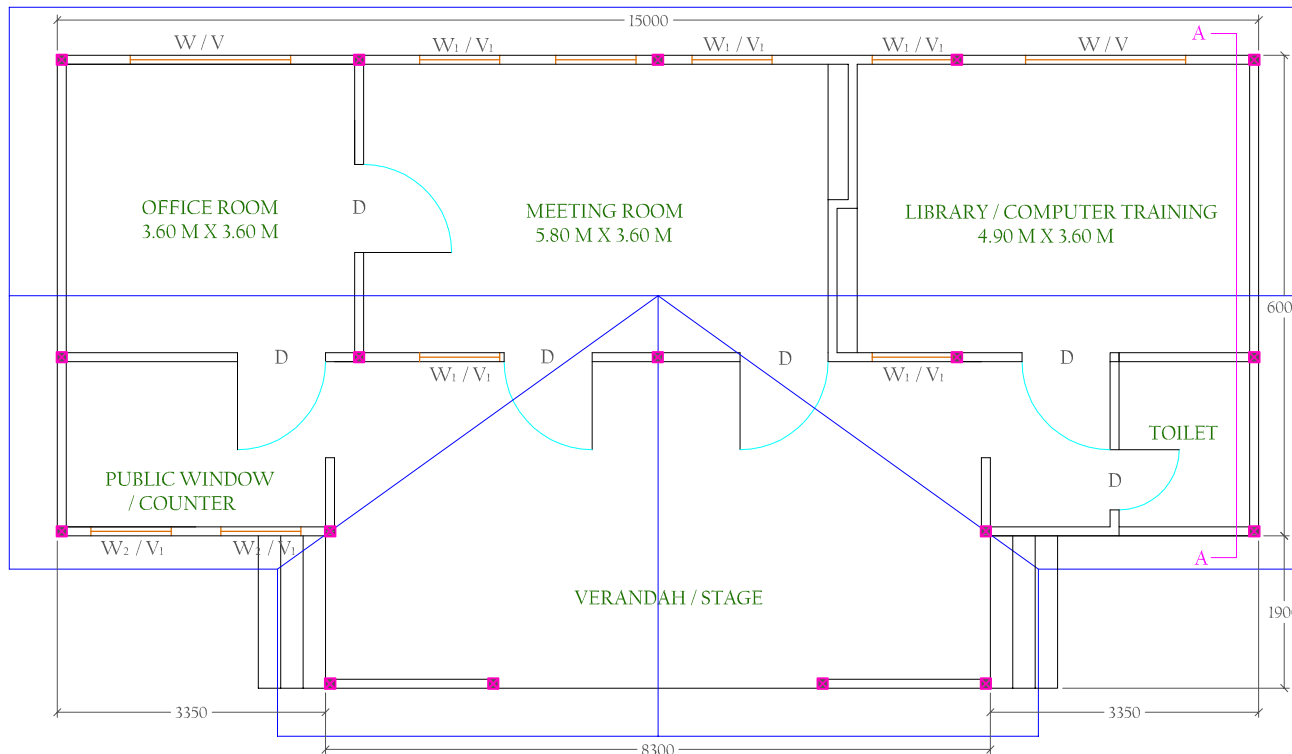

SECTIONAL PLAN WITH ROOF PLAN

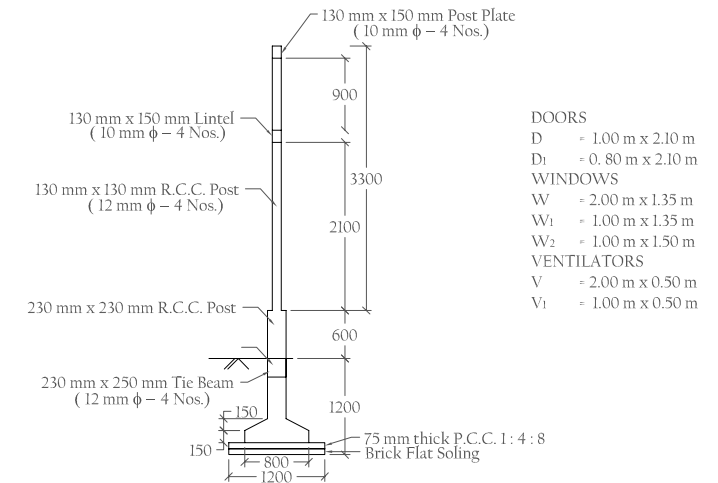

DETAILS OF COLUMN & FOOTING

- DOORS
 D = 1.00 m x 2.10 m
 D₁ = 0.80 m x 2.10 m
 WINDOWS
 W = 2.00 m x 1.35 m
 W₁ = 1.00 m x 1.35 m
 W₂ = 1.00 m x 1.50 m
 VENTILATORS
 V = 2.00 m x 0.50 m
 V₁ = 1.00 m x 0.50 m

A. Rahman
 Jr. Director(Tech.)
 Panchayat & Rural Development : Assam
 Juripar : Guwahati : Assam

Ushabajjali Sarmah
 Jr. Engineer
 Pachim Kaliabor Development Block
 Missa : Nagaon : Assam

Detailed Estimate for the Toilet Block

(Schedule of Rates for PWD Building (Civil works) 2010-11)

1	1.1 Earth work in excavation for foundation tranches of wall, retaining wall, column etc. including refilling the quantity as necessary after completion of the work, breaking clods in return filling, dressing, watering and ramming etc. and removal of surplus earth with all lead and lifts as directed and specified.						
	A) Up to a depth of 2.00m below the existing ground level						
	a) In ordinary soil						
	Post						
	Wall	9X	0.75X	0.75X	0.90=	4.56	m3
		3X	2.05X	0.45X	0.45=	1.25	m3
		3X	2.45X	0.45X	0.45=	1.49	m3
		3X	0.75X	0.45X	0.45=	0.46	m3
		1X	0.90X	0.45X	0.45=	0.18	m3
		3X	1.10X	0.45X	0.45=	0.67	m3
	Steps	2X	1.20X	0.50X	0.30=	0.36	m3
						8.96	m3
							Rs.64.67
							Rs.579.44
2	4.1.1 Providing soling in foundation and under floor with stone / best quality picked jhama brick, sand packed and laid to level and in panel after preparation of sub grade as directed including all cost of labour and materials and if necessary dewatering complete						
	a) Brick flat soling						
	Footings	9X	1X	0.75X	0.75=	50.6	m2
		3X	1X	2.55X	0.40=	3.06	m2
		3X	1X	2.95X	0.40=	3.54	m2
		3X	1X	1.25X	0.45=	1.69	m2
		1X	1X	0.90X	0.40=	0.36	m2
		3X	1X	1.10X	0.40=	1.32	m2
		1X	1X	0.85X	0.40=	0.34	m2
	Steps	2X	1X	1.20X	0.50=	1.20	m2
	Floor	1X	1X	2.65X	1.50=	3.98	m2
		1X	1X	0.85X	1.35=	1.15	m2
		1X	1X	1.05X	1.35=	1.42	m2
		2X	1X	0.85X	1.35=	2.30	m2
		1X	1X	5.80X	0.85=	4.93	m2
						30.34	m2
							Rs.286.37
							Rs.8,688.47
3	2.1.1 Plain cement concrete works with coarse aggregate of sizes 13mm to 32mm in foundation bed for footing steps, walls, brick work etc. as directed and specified including dewatering if necessary, and curing complete (shuttering where necessary shall be measured and paid separately)						
	a) In prop 1:3:6						
		1X	1X	16.57X	0.075=	1.24	m3
							Rs.3,733.00
							Rs.4,628.92
4	18.1.1 Supplying fitting and fixing reinforcement bars conforming to IS code for RCC work/RB walling including straightening, cleaning bending and cutting to proper shape and size up to 1st floor level						
	b) TMT bar						
	I) TATA/SAIL						
	Torsteel 10mm dia						

	Post	9X	4X	3.75X	0.62=	83.70	kg		
	Lintel	2X	4X	6.20X	0.62=	30.75	kg		
		3X	4X	1.70X	0.62=	12.65	kg		
						127.10	kg		
						1.27	Qtl	Rs.5,290.41	Rs.6,718.82
	b) M S Rod 6mm dia								
	Post	9X	24X	0.60X	0.22=	28.51	kg		
	Lintel	2X	40X	0.60X	0.22=	10.56	kg		
		3X	11X	0.60X	0.22=	4.36	kg		
						43.43	kg		
						0.44	Qtl	Rs.5,241.78	Rs.2,306.38
5	3.1.1	Providing form work of ordinary timber planking so as to give a rough finish. Insub structure upto plinth							
	3.1.1.1	Foundation footing, bases of column, tie and the like up to plinyh level							
		ii) Using 25mm thick plank							
		9X	4X	0.60X	0.15=	3.24	m2		
		9X	4X	0.45X	0.15=	2.43	m2		
		9X	4X	0.25X	0.90=	8.10	m2		
						13.77	m2	Rs.140.84	Rs.1,939.37
	3.1.1.3	Column pillars, post and struts.							
		a) Square, rectangular, polygonal in plan or any shape like Tee/L etc. having plan vertical face							
		ii) Using 25mm thick plank							
		Post	9X	4X	0.13X	2.20=	10.30	m2	
		Lintel	2X	2X	6.00X	0.15=	3.60	m2	
			2X	1X	6.00X	0.13=	1.56	m2	
			3X	2X	1.35X	0.15=	1.22	m2	
			3X	1X	1.35X	0.13=	0.53	m2	
						17.20	m2	Rs.213.73	Rs.3,676.16
6	2.2.1	Providing and laying plain/reinforced cement concrete works in prop 1:2:4:(1 cement :2 coarse sand :4 graded stone aggregate, 20mm down) including dewatering if necessary, and curing complete but excluding cost of form work and reinforcement for reinforced cement concrete work.							
		a) Insubstructure Upto plinth level							
		Foundation, footing, columns with basetle and plinth beam, pile camp, base slab, retaining wall, walls of septic tank, inspectionpit and the like, and other works not less than 100mm thickup to plinth level.							
		Post	9X	0.60X	0.60X	0.15=	0.486	m3	
			9X	0.45X	0.45X	0.15=	0.273	m3	
			9X	0.25X	0.25X	0.90=	0.506	m3	
						1.266	m3	Rs.4,734.15	Rs.5,993.43
		b) In super structure from plinth level up to 1st floor level,							
		ii) Columns, pillars, posts, struts, suspended floor, roof, landing, shelf and support, balcony, lintel, sill band, beam, girder, bressumer, cantilever, staircase including preparing the top surface and finishing of nosing.							
		Post	9X	0.13X	0.13X	2.20=	0.335	m3	
		Lintel	2X	5.55X	0.13X	0.15=	0.216	m2	
			3X	1.35X	0.13X	0.15=	0.079	m2	
						0.630	m3	Rs.4,929.24	Rs.3,105.42

7	2.1.3	Providing and laying 25mm thick damp proof coarse with cement concrete in prop. 1:1.5:3 with graded stone aggregate of 10mm down nominal size including providing approved damp proof admixture in proportion as recommended by the manufacturer including etc. complete as directed.		
		2x 6.00x 0.13 = 1.56 m ²		
		3x 1.50x 0.14 = <u>0.59 m²</u>		
		= 2.15 m ²	Rs.150.00	Rs.322.50
8	4.1.4	Brick work in cement mortar with 1st class brick including racking out joint and dewatering if necessary, curing, complete as directed in sub-structure upto plinth level		
	(d) in Prop 1:6	2 x 2.55 x 0.23 x 0.60 = 0.70 m ³		
		2 x 2.95 x 0.23 x 0.60 = 0.81 m ³		
		1 x 2.55 x 0.125 x 0.60 = 0.19 m ³		
		1 x 2.95 x 0.125 x 0.60 = 0.22 m ³		
		2 x 1.25 x 0.23 x 0.60 = 0.35 m ³		
		2 x 0.75 x 0.23 x 0.60 = 0.21 m ³		
		4 x 1.25 x 0.125 x 0.60 = 0.38 m ³		
		2 x 0.75 x 0.125 x 0.60 = 0.11 m ³		
	Steps	2 x 1.20 x 0.30 x 0.20 = <u>0.14 m³</u>		
		3.11 m ³	Rs.4,401.57	Rs.13,688.88
9	1.3	Earth / Sand filling in plinth in layers not more than 15 cm thick including necessary carriage, watering, ramming, etc. complete as directed and specified including payment of land compensation, forest royalty, sales tax and other duties and taxes may be necessary.		
	c) With river sand or silt by truck carriage including loading and unloading			
	Floor	1 x 2.65 x 1.50 x 0.45 = 1.79 m ³		
		1 x 0.85 x 1.35 x 0.45 = 0.52 m ³		
		1 x 1.50 x 1.35 x 0.45 = 0.64 m ³		
		2 x 0.85 x 1.35 x 0.45 = 1.03 m ³		
		1 x 5.80 x 0.85 x 0.45 = <u>2.22 m³</u>		
		6.19 m ³	Rs.322.75	Rs.1,997.82
10	4.1.7	112mm thick 1st class brick nogged wall in cement mortar including racking out joints and curing complete as directed in super structure above plinth upto 1st floor level (Protruding MS rod/ tor steel of column to be embeded in cement mortar and will be measured and paid separately) In Prop. 1 : 5		
	b) In Prop.	2 x 1 x 2.65 x 2.20 = 11.66 m ²		
		2 x 1 x 3.05 x 2.20 = 13.42 m ²		
		1 x 1 x 2.65 x 1.80 = 4.77 m ²		
		1 x 1 x 3.05 x 1.80 = 5.49 m ²		
		6 x 1 x 1.35 x 2.20 = 17.82 m ²		
		2 x 1 x 0.75 x 1.50 = 2.25 m ²		
	Less D	- 4 x 1 x 0.80 x 2.00 = -6.40 m ²		
	V	- 5 x 1 x 0.80 x 0.50 = -2.00 m ²		
		- 1 x 1 x 1.65 x 2.20 = <u>-3.63 m²</u>		
		46.71 m ²	Rs.499.76	Rs.23,343.79
11	9.1.2	Providing wood works in frame (Chowkath) of doors, windows and other similar works wrought, framed and fixed in position in contact with CC or brick masonry wall including supplying fitting and fixing with MS hold fast (40mm x 3mm x 250mm) as per design embeded in cement concrete block in prop. 1:2:4 and two coats kiricide oiling to the timber faces in contact with CC and masonry as directed and specified.		

	b) Hollock / Bonsum / Sundi			
	D -	8 x 2.10 x 0.075 x 0.10	= 0.126 m3	
		4 x 0.80 x 0.075 x 0.10	= 0.024 m3	
	V	10 x 0.80 x 0.075 x 0.10	= 0.060 m3	
		10 x 0.50 x 0.075 x 0.10	= 0.038 m3	
			<u>0.248 m3</u>	
12	9.2.1	Providing undressed wood works in roof truss, refter, purlin, tie and like including hoisting and fixing in position with necessary spikes, nails, including MS straps with bolts and nuts etc. complete with kiricide oiling two coats to all timber members and two caots of anticorrosive paint to MS straps (MS flat, angle cleats, and bolts and nuts required for angle cleats wherever used shall be measured and pad spearately)		
		b) Hollock / Sundi / Sam		
		Post plate	2 x 6.20 x 0.075 x 0.08 = 0.074 m3	
			2 x 1.65 x 0.075 x 0.08 = 0.020 m3	
		Rafter	3 x 2.50 x 0.075 x 0.08 = 0.045 m3	
		Purlin	3 x 7.35 x 0.050 x 0.08 = 0.088 m3	
			<u>0.227 m3</u>	
				Rs.46,853.38 Rs.11,619.64
13	8.1.2	Providing GCI sheet roofing of TATA shaktee/ SAIL including fitting, and fixing of J or L hooks, bolts and nuts with bitumen washer 25mm dia, limpet washer 1.60 mm thick excluding cost of roof truss, purlin etc. 0.50 mm thick 1 x 1 x 2.50 x 7.20 = 18.00 m2		
				Rs.359.88 Rs.6,477.84
14	5.1.10	Cement plaster skirting with cement mortar 1:3 finished with a floating coat of a) 15mm thick		
			2x 1 x 6.25 x 0.50 = 6.25 sq.m.	
			2x 1 x 2.75 x 0.50 = 2.75 sq.m.	
			2x 1 x 1.20 x 0.30 = 0.72 sq.m.	
			2x 2 x 0.30 x 0.15 = 0.18 sq.m.	
			<u>9.90 sq.m.</u>	
				Rs.170.47 Rs.1,687.65
15	5.1.5	65mm thick C.C. floor of 53 mm under layer of CC in prop. 1:3:6 and 12mm thick wearing coarse of cement and plastering in prop. 1:2 laid in panels and finished with a floating coat of neat cement finish		
		Floor	1 x 1 x 2.65 x 1.50 = 3.98 m2	
			1 x 1 x 0.85 x 1.35 = 1.15 m2	
			1 x 1 x 1.05 x 1.35 = 1.42 m2	
			2 x 1 x 0.85 x 1.35 = 2.30 m2	
			1 x 1 x 5.80 x 0.85 = 4.93 m2	
			<u>13.77 m2</u>	
				Rs.435.43 Rs.5,995.87
16	6.2.2	15mm thick cement plaster in single coat on rough side of single or half brick wall for interior plastering upto 1st floor level including arises, internal rounded angles not exceeding 80mm girth, including curing complete as directed. (b) In Cement mortar 1:4		
			5 x 2 x 1.00 x 2.20 = 22.00 sq.m.	
			5 x 2 x 1.35 x 2.20 = 29.70 sq.m.	
			1 x 2 x 1.50 x 2.20 = 6.60 sq.m.	
			1 x 2 x 1.80 x 2.20 = 3.96 sq.m.	
		Less Door	-4 x 1 x 0.80 x 2.00 = -6.40 sq.m.	
		V	-5 x 1 x 0.80 x 0.50 = -2.00 sq.m.	
			<u>= 53.86 sq.m.</u>	
				Rs.95.10 Rs.5,122.09
17	6.2.3	15mm thick cement plaster in single coat on fair side of single or half brick as wall for interior plastering including arises, including curing complete as directed		

Annexure - B

	b) in Cement mortar 1:4		
	2x 2x 6.15 x 2.20 = 54.12 sq.m.		
	2x 1x 1.65 x 2.20 = 7.26 sq.m		
	Less Door -4x 1x 0.80 x 2.00 = - 6.40 sq.m		
	-5x 1x 0.80 x 0.50 = - 2.00 sq.m		
	52.98 sq.m	Rs.94.06	Rs.4,983.30
18	9.9.5 (b) Providing fitting and fixing 1st class local wood (Gamari) battened and framed door and window shutters including oxidised iron butt 25mm thick with 12mm thick battens.		
	Door 4 x 1x 0.68 x 1.96 = 5.33 m2	Rs.1,213.51	Rs.6,468.01
19	9.9.9 Providing fitting, fixing of fully glazed celerestory window with sash bars including fitting and fixing of oxidised MS butt hinges B) With Gamari wood		
	ii) 35mm thick 5 x 1x 0.68 x 0.38 = 1.29 m2	Rs.1,117.41	Rs.1,441.46
20	13.2.1 a) Color washing with lime after and including a coat of white washing after thoroughly cleaning oil, dirt and dust etc. Same as Plastering 106.84 m2	Rs.21.40	Rs.2,286.38
21	Cost of 20 user septic tank (Annexure - C enclosed)		Rs.27,348.45
			<hr/>
			Rs.1,56,630.11
		Less for Contractor's profit =	Rs.15,663.01
		Cost of Sanitary fittings L.S.=	Rs.11,000.00

Cost for the Construction of the Toilet Block = Rs.1,51,967.10

Say, Rs.1,52,000.00
(Rupees One Lakh Fifty Two Thousand only)

Detailed Estimate for the Septic Tank 20 Users
(Schedule of Rates for PWD Building (Civil works) 2010-11)

1	1.1	Earth work in excavation for foundation trenches of wall, retaining wall, column etc. including refilling the quantity as necessary after completion of the work, breaking clods in return filling, dressing, watering and ramming etc. and removal of surplus earth with all lead and lifts as directed and specified	Rs.64.67	Rs.415.18
2	4.1.1	Providing soiling in foundation and under floor with stone / best quality picked jhama brick, sand packed and laid to level and in panel after preparation of sub gradeas directed including all cost of labour and materials and if necessary dewatering complete a) Brick flat soling 1x 3.65 x 1.60 = 5.84 m ²	Rs.286.37	Rs.1,672.40
3	2.1.1	Plain cement concrete works with coarse aggregate of sizes 13mm to 32mm in foundation bed for footing steps, walls, brick work etc. as directed and specified including dewatering if necessary, and curing complete (shutterin where necessary shall be measured and paid separately) a) In prop. 1:3:6 1x 3.65 x 1.60x 0.10 = 0.58 m ³	Rs.3,733.00	Rs.2,165.14
4	2.2.1	Providing and laying plain/ reinforced cement concrete work in prop. 1:2:4 (1 cement : 2 coarse sand : 4 graded stone aggregate, 20mm down) including dewatering if necessary, and curing complete but excluding cost of form work and reinforcement for reinforced cement concrete work. a) In Substructure upto plinth level Foundation, footing, columns with base tie and plinth beam, pile cap, base slab, retaining wall, walls of septic tank, inspection pit and the like and other works not less than 100mm thick up to plinth level 1x 2.70x 0.90x 0.065 = 0.16 m ³ 1x 1.00x 0.15x 0.15 = <u>0.02 m³</u> T = 0.18 m ³	Rs.4,734.15	Rs.852.15
5	4.1.4	Brick work in cement mortar with 1st class brick including racking ut joint and dewatering if necessary, curing complete as directed in sub-structure utpo plinth level b) In prop. 1:4 2x 3.45x 0.25x 1.35 = 2.33 m ³ 2x 0.90x 0.25x 1.35 = 0.61 m ³ 1x 0.90x 0.125x 1.05 = 0.12 m ³ 1x 0.90x 0.125x 1.05 = <u>0.12 m³</u> = 3.17 m ³	Rs.4,401.57	Rs.13,952.98
6	6.2.2	15mm thick cement plater in single coat on rough side of single or half brick wall for interior plastering upto 1st Floor level including arises, internal rounded angles not exceeding 80mm girth, including curing complete as directed. b) In Cement mortar 1:4 01.04 2x 1x 3.65x 0.30 = 2.19 m ² 2x 1x 1.40x 0.30 = <u>0.84 m²</u> = 3.03 m ²	Rs.95.10	Rs.288.15
7	25.12	Providing precast RCC slab in prop. 1:2:4 reinforced with 10mm bars @ 150mm cement both ways tying with 20 gauge annealed wire with necessary shuttering including fixing b) 75mm thick slab 1 x 1x 3.45x 1.40 = 4.83 m ²	Rs.1,085.06	Rs.5,240.84

- 8 5.1.10 Cement plaster skirting with cement mortar 1:3 finished with a floating coat of neat cement including rounding of junction with floor

a) 15mm thick

2 x	1x	2.70x	1.35	= 7.29 m2
3 x	2x	0.90x	1.20	= 6.48 m2
1 x	1x	2.70x	0.90	<u>= 2.43 m2</u>
				16.20 m2

Rs.170.47 **Rs.2,761.61**

Total Cost = Rs.27,348.45

(Rupees Twenty even Thousand Three Hundred Forty Eight & Paise forty five only)

SEPTIC TANK WITH SOAK PIT

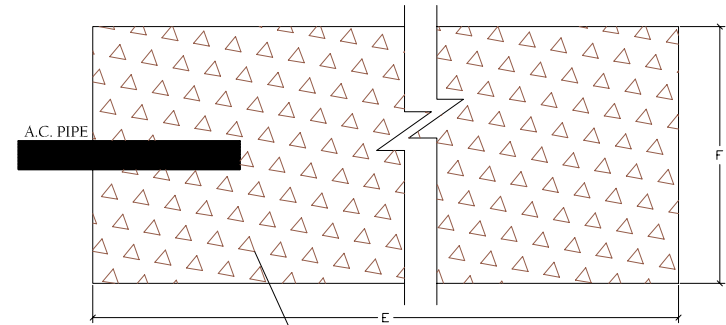
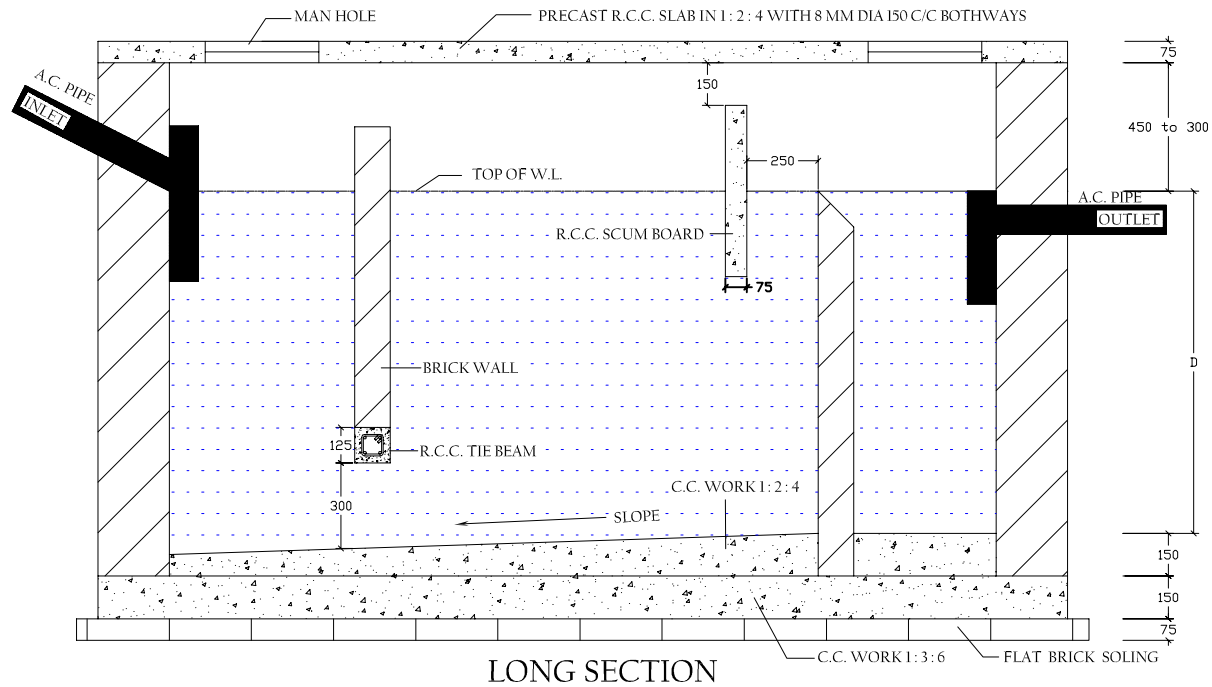

SOAK PIT SECTION

BRICK BATS OR DRY CHARCOAL

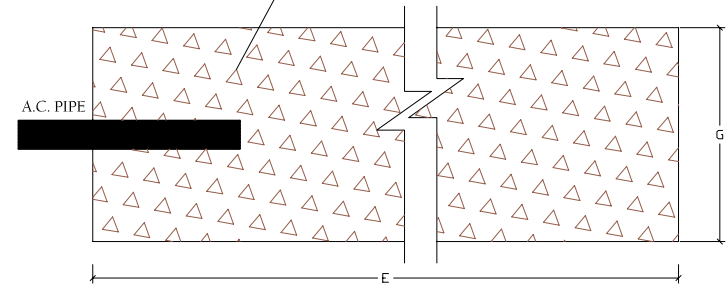
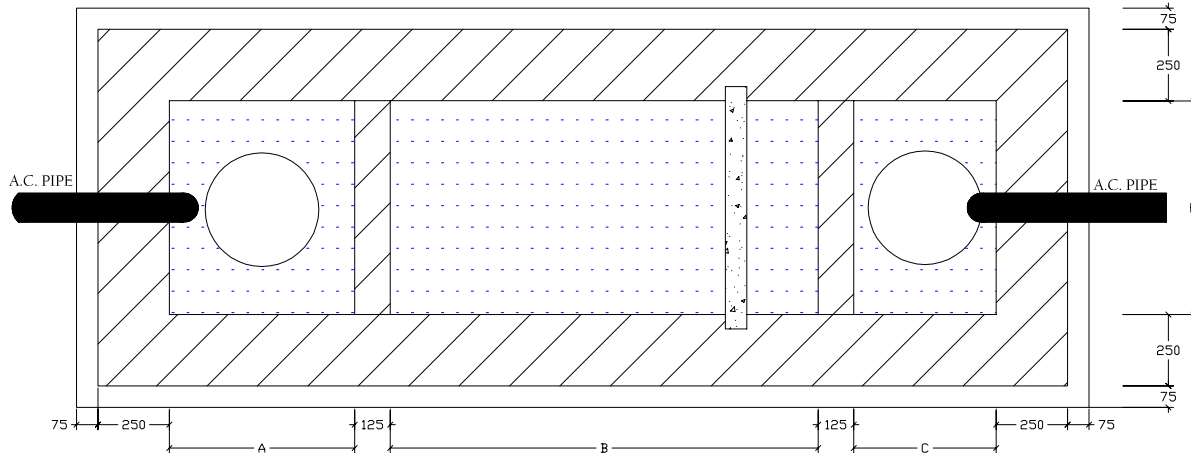

SOAK PIT PLAN

* ALL DIMENSIONS ARE IN MM

DRAWN BY
Dhrubajyoti Sarmah
 Jr. Engineer
 Pachim KALIabor Development Block
 Missa : Nagaon : Assam